

www.amquartz.com

www.amquartz.com

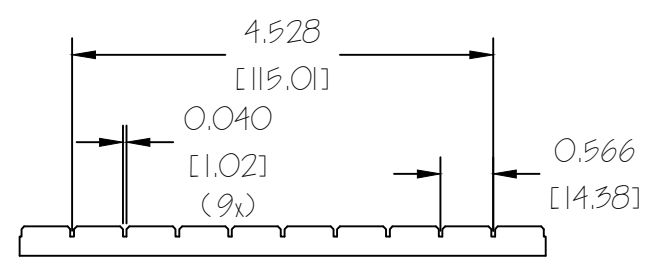
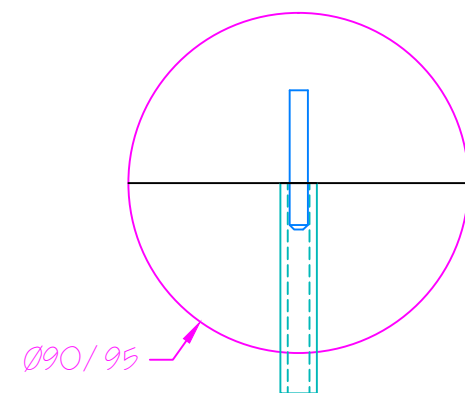
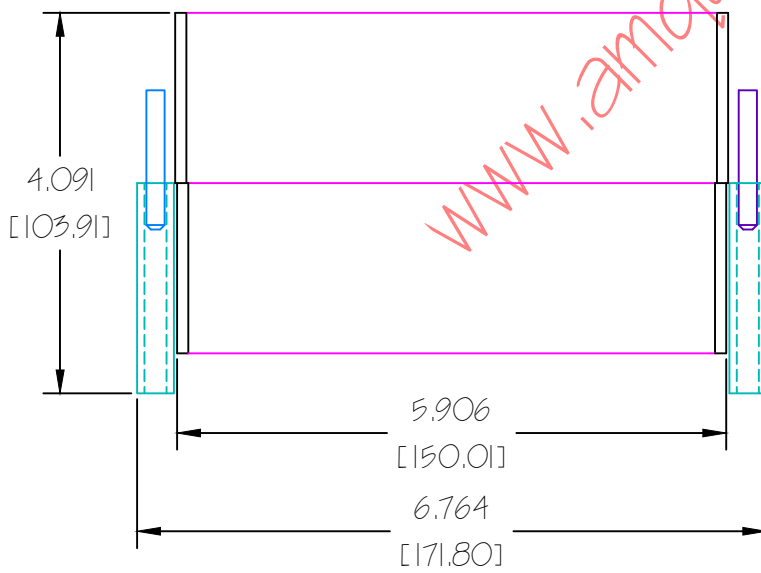
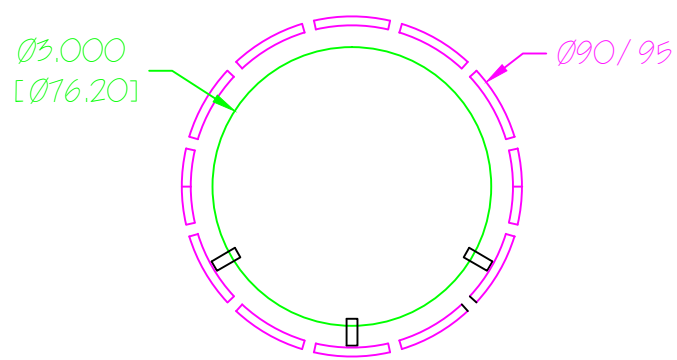

TOLERANCES	
DECIMAL INCHES	MILLIMETERS
X.X = +/- 0.0050	X = +/- 0.127
X.XX = +/- 0.0020	X.X = +/- 0.508
ANGULARITY +/- 1.5	Tube & Rod Per Momentive Standard Tolerances.
PROPRIETARY THE INFORMATION CONTAINED HEREIN IS THE PROPERTY OF A.M. QUARTZ CORPORATION, AND MAY NOT BE REPRODUCED OR DISCLOSED IN WHOLE OR IN PART WITHOUT THE WRITTEN PERMISSION OF A.M. QUARTZ CORPORATION.	

A.M. Quartz Corporation
 2400 Alabama Drive
 Gainesville, TX 76240
 Phone: (940) 612-1011 Fax: (940) 612-1014
 Website: www.amquartz.com Email: amquartz@amquartz.com
 Custom Quartz LTO 3" Wafer Carrier 9 Slots
 MATERIAL MOMENTIVE 214 Part # AMQ-2-9-040 CB

Part # AMQ-2-9-040 CB.dwg